

W.S. Darley & Co.

TRUSTED WORLDWIDE SINCE 1908



Pump Plant & Engineering

1051 Palmer Street
Chippewa Falls, WI 54729
Phone 800-634-7812

Pump Sales & Corporate

325 Spring Lake Dr.
Itasca, IL 60143-2072
Phone (708) 345-8050
Fax (708) 345-8993

Date: _____

Bill To: _____

P.O. No.: _____

Customer No.: _____

Order Completed By: _____

Desired Delivery Date: _____

End Customer: _____

Customer Contact:

Tel No.: _____

Fax No.: _____

Email: _____

Ship To: _____

PUMP ORDER FORM

"2BE (Below 18 HP)"

Please review the order form before starting. If any challenges arise, please call our Customer Service Department at 1-800-634-7812 for assistance. We will be glad to help. Please fill in the information **completely**.

Type of Pump (Please check choice):

- 2BE14V-Twin
- 2BE10YD (Note: Electric or Rope Start)
- Pump Only

Seal Type

- Packing
- Mechanical Seal

Optional Equipment Available

Base (Please check choices):

Skid

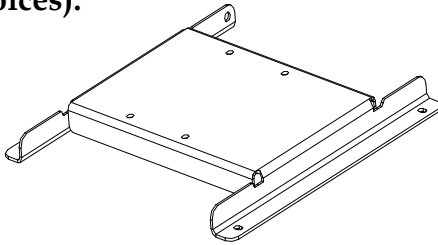

Roll Cage

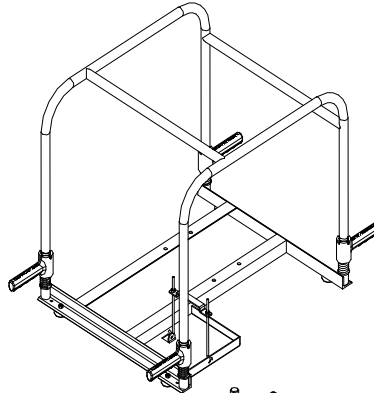

Base with Handles

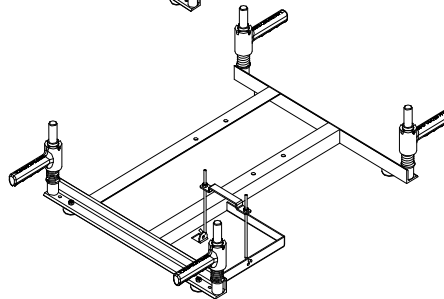

Fuel Tank and Discharge Head (Please check choices):

(Pump discharge is available as a flange OR a discharge head.)

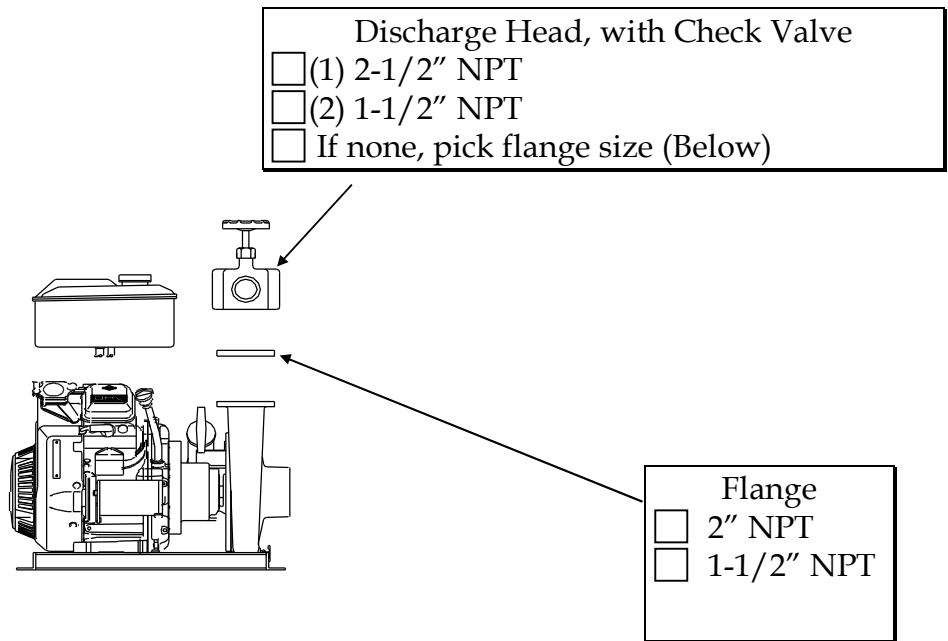

(Options Continued)

Discharge Thread Adapters (Please check choice):

- | <u>Size</u> | <u>Quantity</u> |
|--|---|
| <input type="checkbox"/> 1-1/2" NH x 1-1/2" NPT | <input type="checkbox"/> 1 <input type="checkbox"/> 2 |
| <input type="checkbox"/> 2-1/2" NH x 2-1/2" NPT | <input type="checkbox"/> 1 <input type="checkbox"/> 2 |
| <input type="checkbox"/> Special Treads: Type: _____ Size: _____ | |

Discharge Valve Quantity: _____

Discharge Cap Quantity: _____

Suction Thread Adapters, with Screen (Please check choice):

- 2-1/2" NH x 3" NPT
- 3" NH x 3" NPT
- Special Treads: Type: _____ Size: _____

Suction Cap Quantity: _____

Control Panel (Please check choice):

- Remote Panel (Shipped loose)
- OR**
- Mounted Panel

Volute Orientation:

Standard

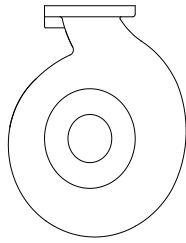

9:00

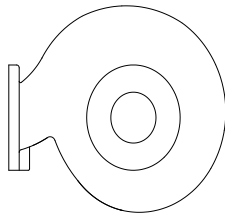

3:00

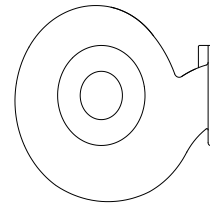

(Options Continued)

Spark Arrestor (Please check choice): (2BE14V-Twin only)

- Yes
 No

Primer (Please check choice):

- Electric Primer (12V): (Fluid or Fluid less)
 Exhaust Primer
 Hand Primer (Mounted or Shipped Loose)
 None

Loss of Prime Protection System: Yes No

Suction Hose:

Yes 10 ft. lengths OR Yes Custom length: _____

*Qty: _____

*List Coupling Type: _____

No

Master Drain (shipped loose): Yes No

Thermal Relief Valve: Yes No

Crating options/Instructions

- Standard Box
- Wood Crate, Bark Free
- Heat Treated Skid (Export)
- Oversized Domestic Skid and Box (38x44)
- Oversized Export Skid and Box (38x44)
- Oversized Heat Treated Skid (Export 38x44)
- UPS Pump Only-Cardboard Box

- Special Crating Instructions: _____

Additional Comments or Special Instructions

BSP threads instead of NPT
