

NO.	DESCRIPTION	PART NO.	QTY.
1	ASSEMBLY - PRIMER, ROTOR	4420105	1
2	BEARING - OILITE, 0.626 ID	1760023	2
3	COUPLING - R44093	2404500	1
4	CYLINDER - VACUUM PUMP	1020800	1
5	HEAD - CYLINDER, INBOARD	2808904	1
6	HEAD - CYLINDER, OUTBOARD	2808800	1
7	NCS - .313-18 x 1.00, SST	5400610	4
8	KEY - SQ., 0.19 x 0.62 GR2	3602425	1
9	KEY - WOODRUFF, 606	3602200	1
10	MOTOR - PRIMER, 12V	4223400	1
11	NUT - HEX., .313-15, SST	5403024	2
12	O-RING - 3.50 x 3.69 x 0.09	3601101	2
13	OIL SEAL - 0.625 ID x 1.128 OD	3600505	1
15	PLUG - PIPE, 0.250, BR SQ HD	1080594	1
16	STRAP - GROUND, 12V PRIMER	2600516	1
17	WASHER - ROTOR, ELEC PRIMER	4407601	4
18	WASHER - FLAT, 5/16, STEEL	3603802	2
19	WASHER - LOCK, 0.313 ID	3603502	6

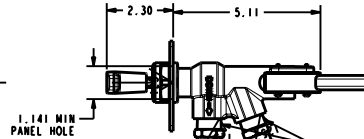
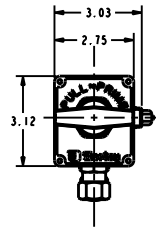

SCALE 1/2

APPLY LOCTITE PST 565 OR TEFLOW THREAD TAPE FINGER TIGHT PLUS 1/2 TURN DO NOT OVER TIGHTEN

NOTE:
 FOR CROSS SECTION AND EXPLODED VIEW DRAWING SEE DVC0203, DVC0204 & DVC0205
 - ALSO, WHEN REPLACING THE OLD VERSION OF THIS VALVE WITH THIS NEW VERSION; BUSHING 1762500 CAN BE USED TO RETROFIT IT TO THE EXISTING PANEL.

REVISIONS				
LTN	DESCRIPTION	DATE	CHK NO.	APP'D
4	REMOVED FIRST PLUG	8/15/19	3226	AAN

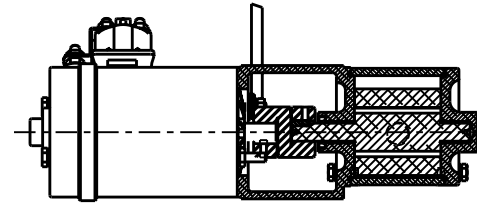

SECTION A-A
SCALE 1/2

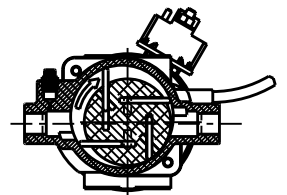

SECTION B-B

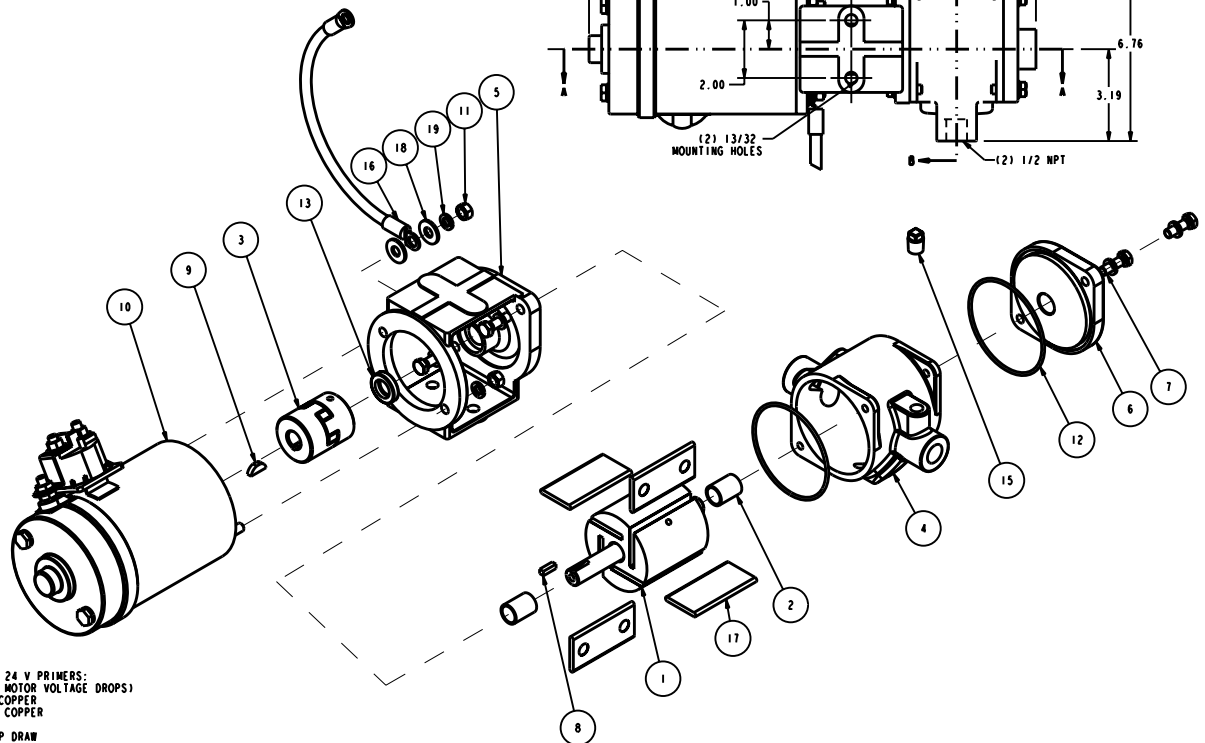
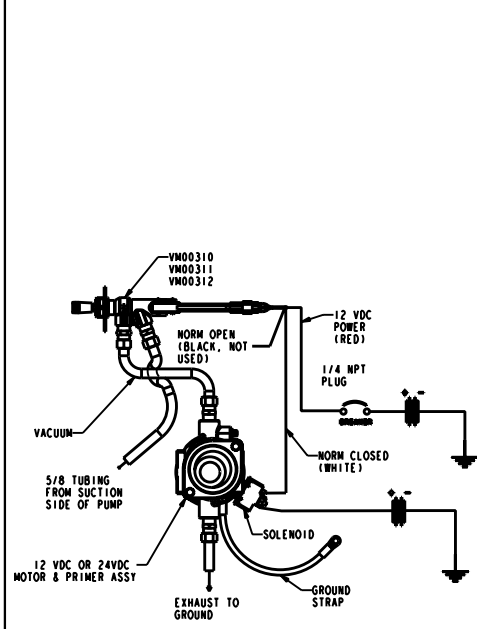
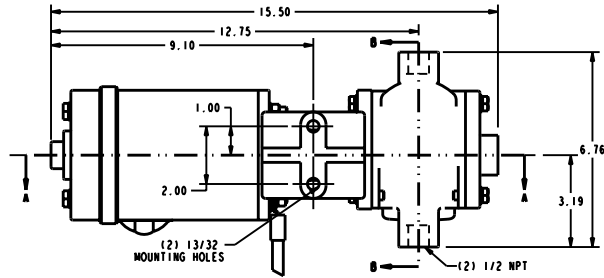

NOTE:
 MOUNT WITH EXHAUST OUTLET DOWN
 CONNECT 4 GA COPPER GROUND STRAP TO CLEAN, PAINT FREE GROUNDING SURFACE
 IF SUPPLIED GROUND STRAP IS REMOVED FROM ASSEMBLY, RETIGHTEN CYLINDER HEAD ADAPTER RETAINING NUTS EQUALLY TO 90 IN. LB.
 POSITIVE LEAD WIRE SIZES FOR 12 V & 24 V PRIMERS:
 PER SAE STANDARD 541J (MAX STARTING MOTOR VOLTAGE DROPS)
 0' TO 20' : : : : 80 (12V), 83 (24V) COPPER
 0' TO 25' : : : : 800 (12V), 82 (24V) COPPER
 THESE GAGE WIRES CORRESPOND WITH AMP DRAW REQUIREMENTS FOR EACH MOTOR, AS WELL AS IN RELATION TO RESISTANCE OVER GIVEN LENGTH.
 12 V = 240 AMP
 24 V = 140 AMP

WEIGHT = 27 LB (12.1 KG)

REMOVE SHARP EDGES		1 INCH (25.4 MM) (SMALL THEFT)	OLD PART NO.	TOLERANCE	DATE 18-Apr-08	SCALE 1/2
MATERIAL DESCRIPTION:		MATERIAL NO.	PATTERN NO.	AS SHOWN	DATE 18-Apr-08	SCALE 1/2
THIS DRAWING IS THE PROPERTY OF D.C. BENTLEY AND CO. UNAUTHORIZED REPRODUCTION IS PROHIBITED.		ALL DIMENSIONS IN INCHES UNLESS NOTED		DO NOT SCALE PRINT		DVC0207